

Worthington Direct-Acting Simplex Steam Pump from the *USS Monitor*

Historic Mechanical Engineering Landmark
The American Society of Mechanical Engineers

August 25, 2016

USS *Monitor* Center at The Mariners' Museum and Park
Newport News, Virginia

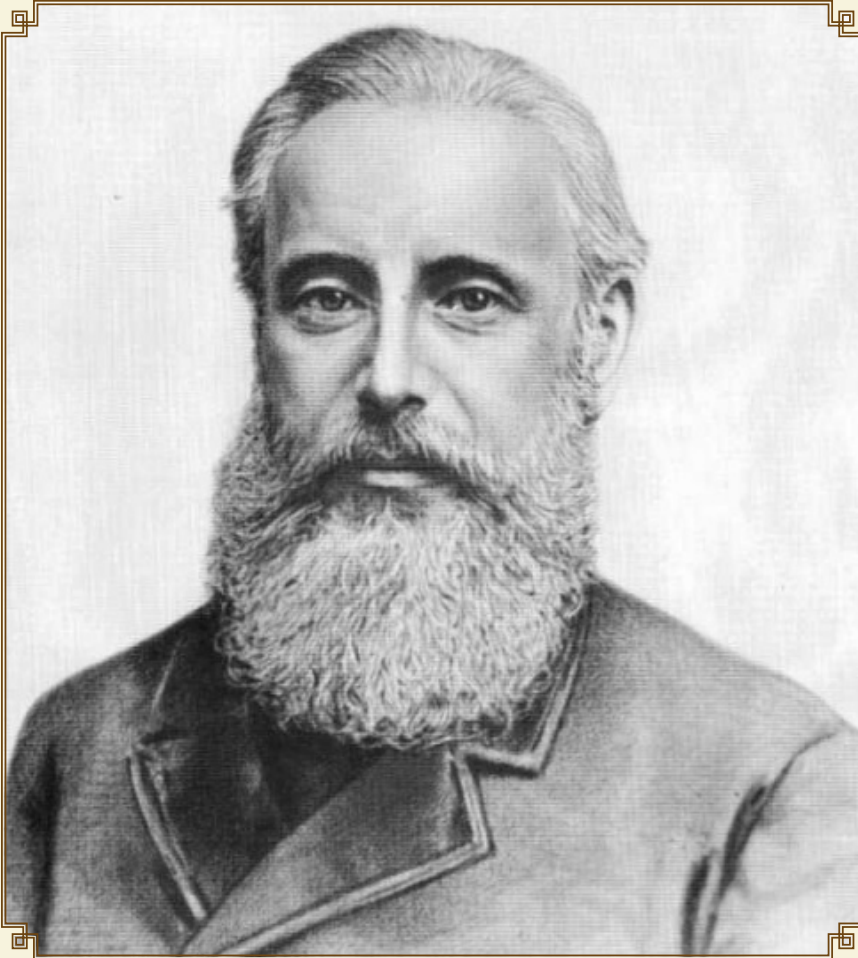

Henry Rossiter Worthington, age 48
Courtesy of Wikipedia.com

“Through peace and war, prosperity and depression, this organization has never lost the inspiration of its engineer-founder. Grown far beyond his dreams, the corporation today offers living, aggressive proof of the force of Henry R. Worthington’s ideas.”

—Worthington Pump and Machinery Corporation,
100 years, Worthington, 1840-1940, 1940.

“In view of apparently insuperable difficulties overcome, I regard your pumping engine as the greatest achievement in Hydraulic Engineering in our time.”

—John Ericsson to Henry Worthington, 1880
Worthington Pump and Machinery Corporation,
100 years, Worthington, 1840-1940, 1940.



Captain John Ericsson
Courtesy of The Mariners' Museum and Park

Inventor Henry R. Worthington is the epitome of 19th century engineering achievement and innovation. A product of New York public schools, he had no upper level education, yet his curiosity and tenacity helped him become a highly respected mechanical engineer. Canal navigation was a keen interest for Worthington. As early as 1840, at age 23, he had an experimental canal boat in operation for which he invented an independent automatic feeding boiler pump, his first patent.

In 1845 he partnered with William H. Baker to form Worthington & Baker Works, located near the old Navy Yard in Brooklyn. His direct-acting simplex pump, the precursor of many others, was patented in 1849. The U.S. Navy purchased the first Worthington pumps for the USS *Susquehanna* in 1850.

His own training and experience led Worthington to value formal career education. In 1853 he helped establish the Brooklyn Collegiate & Polytechnic Institute, today's New York University Tandon School of Engineering. Worthington served on its first board of trustees.

Worthington's direct-acting duplex steam pump was patented in 1859. This pump ultimately became an industry standard.

In January 1862 the U.S. Navy purchased two of his simplex steam pumps for general service on the ironclad USS *Monitor*. By prolonging its time afloat, these pumps helped save the lives of 41 crew members when the ship sank in a storm off Cape Hatteras, North Carolina, in December 1862. The USS *Monitor* pumps are probably the oldest surviving examples of Worthington's simplex design.

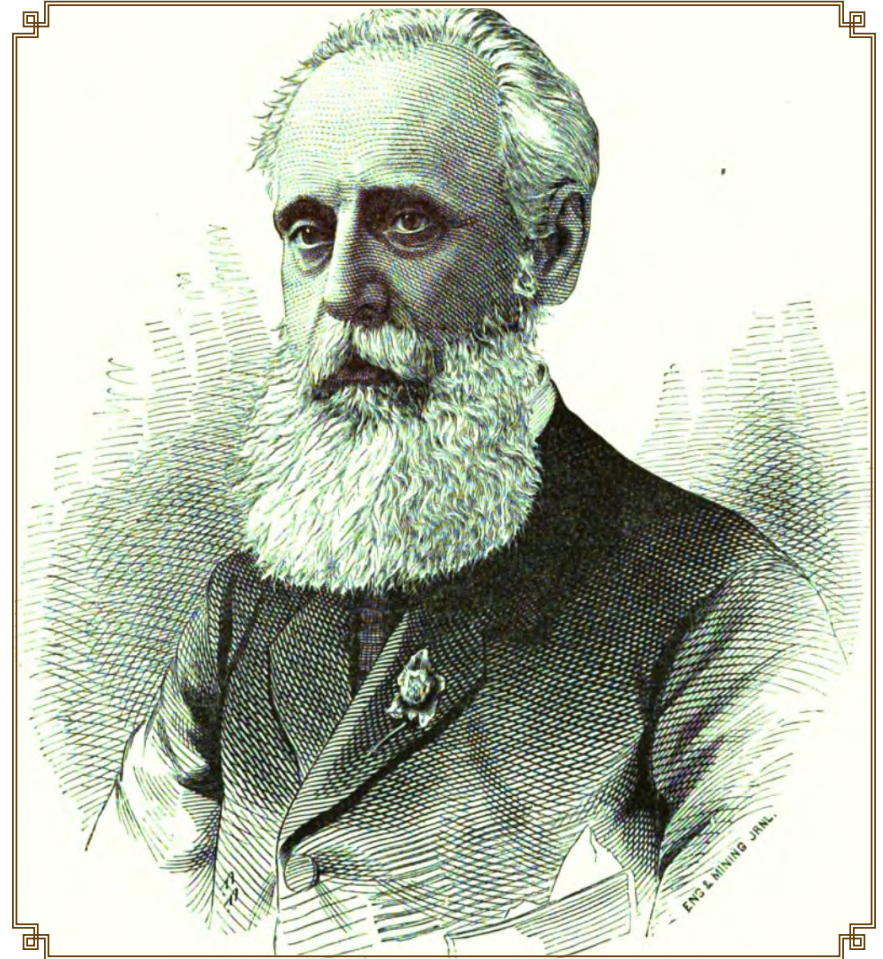

Henry R. Worthington
Engineering and Mining Journal, Vol. 32. (July-December 1881).
Courtesy of The Mariners' Museum and Park

Henry Rossiter Worthington

TIMELINE

1817	<p>Born December 17, in New York City, to Frances Meadowcraft and Asa Worthington, engineer and millwright, co-owner of Hope Flour Mills.</p> <p>Young Henry, the only male child, shows great aptitude for mechanics and his interests lead him to pursue matters away from the family business.</p>	1853	Helps establish the Brooklyn Collegiate & Polytechnic Institute.
1839	<p>Marries Sarah Newton of Alexandria, Virginia, daughter of Commodore John Thomas Newton. The couple has six children; only one of their sons, Charles, is active in his father's business.</p> <p>Becomes hydraulic engineer, focusing his attention on the problems of city water supply.</p>	1854	Builds the first direct-acting water-works steam engine for the City of Savannah. (By 1884, 245 U.S. cities are using Worthington Pumping Engines in their waterworks.)
1840	His interest in canal navigation leads to his first invention - an independent, automatic boiler feed pump for a steam canal boat for which he receives his first patent, No. 3677, on July 24, 1844.	1857	Invents the direct-acting duplex pump; the first is installed at the Hotel Saint Nicholas, New York City.
1845	Partners with William H. Baker to form Worthington & Baker Works in Brooklyn. Success comes in their steam pumps' applications for marine use on merchant and naval vessels.	1859	Establishes a pump manufacturing plant in New York, employing over 200 men. Perfects and patents the direct-acting duplex steam pump.
1849	Obtains patent No. 6274 for the direct-acting simplex steam pump on April 3.	1862	Worthington changes the name of his firm to Henry R. Worthington, New York.
1850	U.S. Navy buys first Worthington pumps for the USS <i>Susquehanna</i> .	1880	<p>A key founder of the American Society of Mechanical Engineers (ASME), Worthington serves as its first vice president.</p> <p>Dies December 17, age 63, in Tarrytown, New York. He is survived by his widow, two sons, and two daughters.</p>

Worthington's signature from *The Worthington Steam Pumping Engine: History of its Invention and Development*, Henry R Worthington, 1886.

The Evolution of the Worthington Pump: An American Invention

Henry R. Worthington's industrial career began in the mid-1800s when, at age 23, he developed a steam-powered paddle wheel canal boat in response to a call from the state of New York to expand the economic transportation system on the Erie Canal. Because the main engine had to idle while passing through the canal's lock systems, it was not available to maintain boiler feed water. To correct this problem, Worthington developed a small, independent, direct-acting, feed-water steam pump, first employed in September 1840, and patented July 24, 1844 (Fig. 1).

The pump consisted of a steam engine connected by a common rod to a single-action, piston-driven water pump. This invention changed hydraulic engineering forever. Previously, steam pumps had relied on beams, cranks, and fly wheels to transmit power between engine and pump, making them large and unwieldy. Worthington's direct-action design, perfected in the years that followed his initial concept, made steam pumping engines more compact and efficient, steadily expanding their scope of operations.

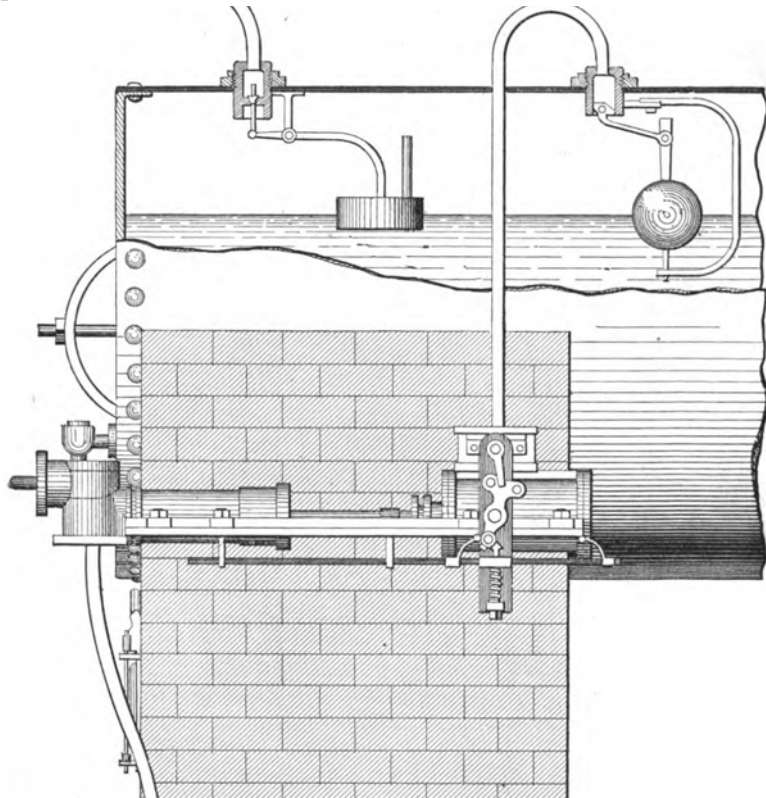

Fig. 1: Patent Drawing of H.R. Worthington's First Pump Design.
Patent No. 3677, 1844, United States Patent Office.

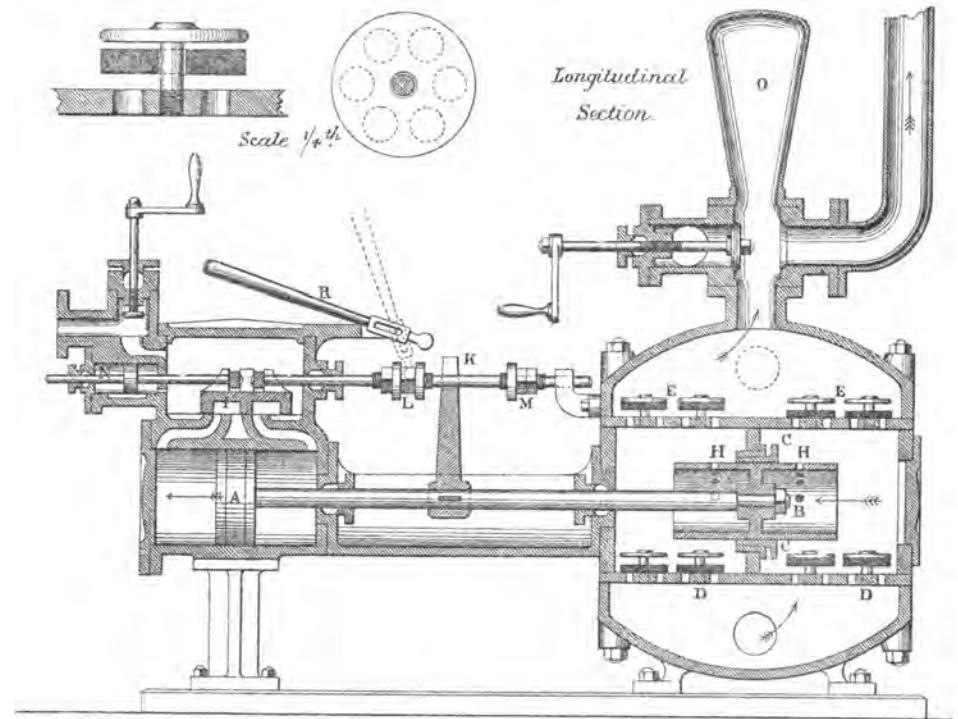

Fig. 2: An earlier generation of Worthington's pump at King's Cross Station, London, its schematic is most like that of the *Monitor's*.
Proceedings from the Institute of Mechanical Engineering, 1852.

DEVELOPMENT OF THE SIMPLEX PUMP

Over the next ten years, Worthington experimented with various steam valve mechanisms eventually developing, with his partner William H. Baker, a direct-acting steam pump with a simple slide valve, known as the "B" valve. This pump, also referred to as a simplex steam pump, directly connected a single steam engine to a double-acting water pump (Fig. 2). As the steam engine's piston moved back and forth, it pulled/pushed a water pump plunger, drawing water in through a series of rubber valves on one side and conversely, pushing it out on the other.

STEAM ENGINE INNOVATION

To control the piston's movement, the "B" valve was mounted above it, directing incoming steam to either side of the piston, while allowing used steam to exit the middle of the engine through a passageway (Fig. 3). To actuate the valve, a tappet-arm fixed to the piston rod engaged adjustable stops, called tappets, along a valve rod. A small secondary piston was mounted in line and functioned like a spring which kept the valve from jamming. This engine maintained full steam pressure during the main piston's entire stroke, unlike an expansion engine, removing the need for a flywheel.

Fig. 3: A Worthington pump's steam engine showing Slide Valve (A), Tappet Arm (B), Tappets (D), Piston (E), and Secondary Piston (C). Björling's *Practical Handbook on Direct-acting Pumping Engine and Steam Pump Construction*, 1889.

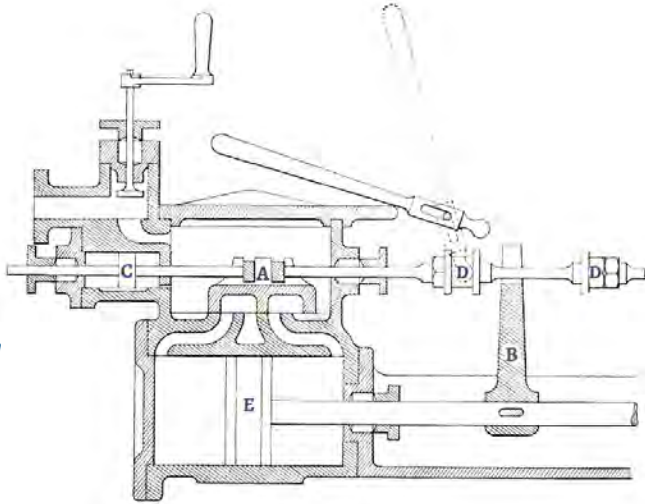

WATER PUMP ADVANCEMENT

On the steam pump's water-end, Worthington also experimented with several designs using radial, or flap valves (Fig. 4). The flap valve was an oblong, flat metal component with relief ports cast into it, placed in each chamber, governed by a flat, hard, brass spring.

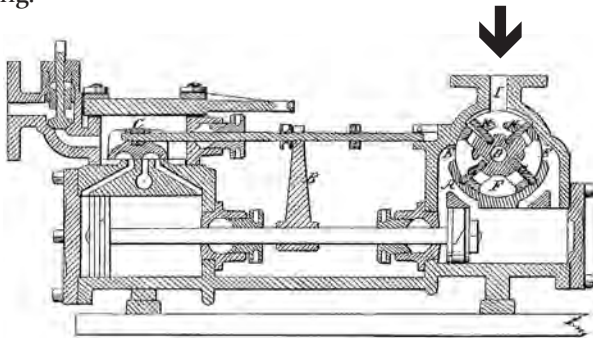

Fig. 4: Worthington water pump. Patent No. 6274, "Method of Ensuring the Action of the Valve in Direct-action Pumping Engines." April 3, 1849. U.S. Patent Office.

In 1850, Worthington substituted the radial valve design with multiple poppets composed of half-inch India rubber disks that rode on brass spindles mounted on two valve decks. Suction valves were located on the bottom deck with the discharge valves above. Using an increased number of small valves was preferable to a few larger valves because they distributed water flow through more passages in the deck, causing minimal lift to the valves. This greatly reduced leakage caused during the reversing of the plunger and reduced valve bulk, noise, and the potential for damage by debris, while permitting higher piston speed and enabling simple replacement.

In addition, Worthington started using a double-acting plunger instead of a piston. This invention simplified pump construction, improved operation, and facilitated maintenance. A piston is a solid component moving in a cylinder made tight by piston rings. The plunger works through a metallic packing ring mounted in the center of the pump, creating two separate water chambers. An advantage of the plunger is that the ring and plunger could be replaced with a larger or smaller version to adjust the power of the pump and steam ends. In addition, the packing ring could be replaced more readily if damaged by gritty water. The plunger barrel had holes on each end, permitting pressure relief at every stroke's end.

In 1859 Worthington again improved his pump design by patenting the direct-acting duplex steam pump consisting of two simplex pumps mounted side-by-side (Fig. 5). The action of one pump moved the steam valves of the other, resulting in uniform discharge and pressure. This marked another advance in hydraulic engineering which ultimately became an industry standard.

Fig. 5: The improved water pump showing the double-acting plunger and poppet valves.

The Worthington Steam Pumping Engine: History of its Invention and Development, 1887.

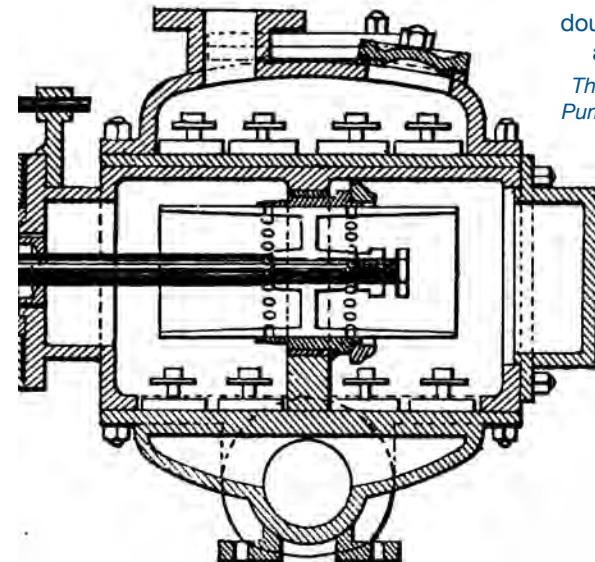

The Worthington Pumps and the Ironclad

At the onset of the Civil War, the U.S. Navy's fleet did not include ironclads; its most powerful ships were six steam-powered unarmored frigates. Knowing that a Confederate ironclad was under construction to break the blockade of Southern ports, the U.S. Navy, in 1861, began construction of its own ironclad vessels. The most successful of these, the USS *Monitor*, was designed by Swedish-born American, Captain John Ericsson.

Ericsson utilized two Worthington direct-acting simplex steam pumps for general service including auxiliary boiler feed and firefighting on the *Monitor*. The primary advantages of these pumps, compared to contemporary flywheel and beam pumps, were their compact size and lightweight design – vital features in a marine application.

The *Monitor's* pumps were likely purchased directly from the Worthington & Baker Works location near Greenpoint, New York, where the *Monitor* was being built. A sales receipt dated January 10, 1862, signed by Worthington, shows the pumps were sold for \$582.22. Proud of his inclusion in this national project, Worthington said, "The engines and

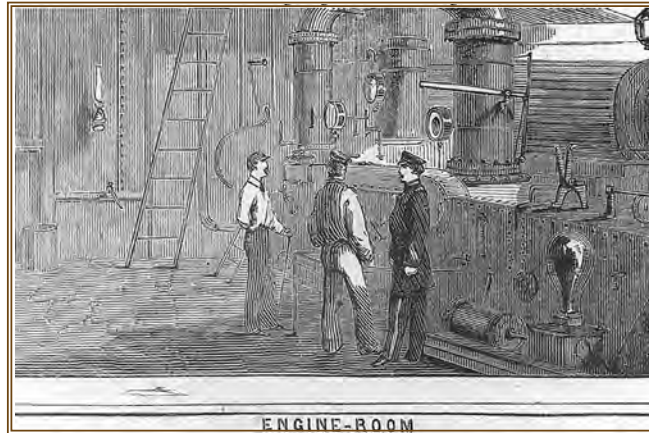

Engraving of USS *Monitor* Engine Room, *Harper's Weekly*, April 1862.

Courtesy of Naval Historical Center, Photo #NH 5881

boilers will be made of the best material and the most perfect workmanship and all modern approved improvements will be applied."

The Worthington pumps helped save the ship from sinking twice on its maiden voyage from New York to Hampton Roads, Virginia, in early March 1862. They saw their final service as bilge pumps on New Year's Eve, 1862. The USS *Monitor* left Hampton Roads en route to Beaufort, North Carolina, on December 29. The *Monitor's* commander, J.P. Bankhead, reported the weather as clear and pleasant, but that changed on the evening of December 30 as the wind and seas increased. The *Monitor* was plunging heavily in the waves, taking on water. At approximately 7:30 p.m., the ship's two Worthington pumps and bilge injection pumps were utilized and the large centrifugal pump was readied. Around 11:30 p.m., the engine and pumps stopped as seawater entered the boilers. By early morning, December 31, *Monitor* was gone. However, 41 men were saved in large part because the pumps kept the ship afloat for nearly six hours.

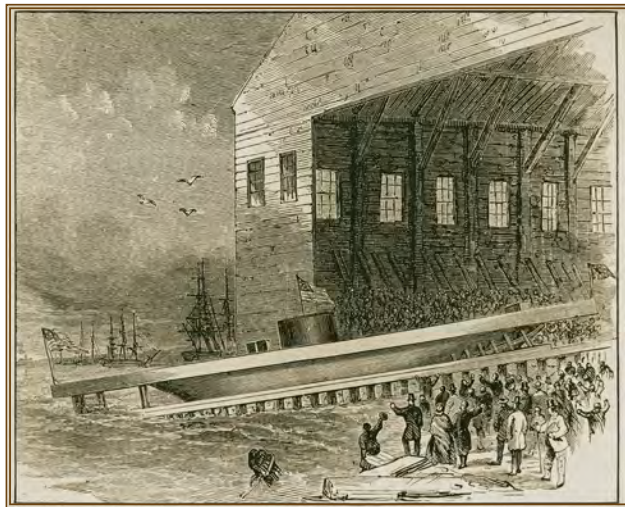

The *Monitor* is launched at Greenpoint in Brooklyn, New York, January 30, 1862.

Courtesy of The Mariners' Museum and Park



Starboard Worthington pump



Port pump during conservation.

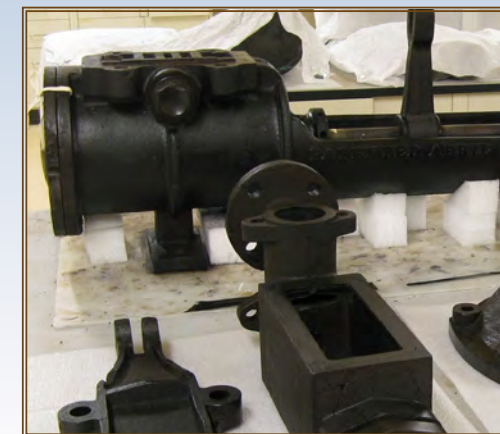

Port pump

Images courtesy of The Mariners' Museum and Park

Recovery and Conservation

The ironclad *Monitor's* wreck site was discovered in 1973 with guardianship of the site falling under the National Oceanic and Atmospheric Administration (NOAA). The *Monitor* National Marine Sanctuary was established in 1975; and in 1987, The Mariners' Museum and Park, "America's National Maritime Museum," in Newport News, Virginia, was designated the official repository of all recovered *Monitor* artifacts.

Starting in the late 1990s, NOAA and the U.S. Navy undertook a large-scale recovery of *Monitor* artifacts that sat on the bottom of the ocean, approximately 235 feet deep, covered in silt and sand, gathering concretion for almost 140 years. In 2001, the majority of the ship's engine room was retrieved, and among the artifacts recovered were the *Monitor's* Worthington pumps.

Upon excavation, the artifacts were transported to The Mariners' Museum's USS *Monitor* Center for conservation, curation, and display. Since 2001, the pumps have been undergoing conservation.

In 2007, the Batten Conservation Complex opened within the *Monitor* Center, becoming the largest marine archaeological metals conservation facility in the world, housing over 210 tons of materials from the *Monitor*. The Complex was awarded the prestigious Keck Award by the International Institute for Conservation of Historic and Artistic Works (IIC) in 2006, largely because the *Monitor* Center's design provides unprecedented visitor access to the conservation process. The webcams in the Wet Lab allow national and international visitors to view conservation in action.

Today, the Worthington pumps are housed in the Complex's Harden-Hoeffler Dry Lab, undergoing the final phases of treatment. They proudly sit for "Behind-the-Scenes" visitors to see while they explore the space and view other nearly-conserved and rarely seen *Monitor* artifacts.



Worthington pump before conservation.



Pump and components after treatment.

Mariners' Museum and Park



Interior of *Monitor's* engine room prior to recovery showing the port Worthington pump.

Courtesy of NOAA, Monitor Collection, Monitor National Marine Sanctuary

The Worthington pumps' conservation is scheduled to be completed in 2018 when these artifacts will be displayed. The story of the pumps' technological invention, pumping technology and practical application is made all the more compelling when the tales of the ironclad's sailors are brought to light.

After more than a decade of research, conservators at the USS *Monitor* Center believe that the two Worthington simplex pumps from the *Monitor* are the only surviving examples of their kind. Their conservation and display allow the contributions of inventor Henry R. Worthington to be shared for generations to come.

On the Road– A Working Worthington Replica

The *Monitor* Center has crafted the only fully operational replica of one of the *Monitor's* Worthington pumps. Modern laser imaging, 3-D printing, and basic foundry and machine shop practices were combined to build a pump in every respect similar to the original, providing a direct connection to mid-19th century technology. A collaborative effort, this was a public–private partnership between government, academic, corporate, and private resources.

Now visitors can see a functioning pump that throws water alongside the fragile originals. The replicated pump brings history to life for museum visitors of all ages, school groups, interested organizations, and adult learning programs. Subjects include, “Teaching STEAM Technology,” “19th Century Engineering,” and “Replicating History.”

An inaugural road trip for the pump replication project will celebrate *Monitor's* Worthington pumps as an ASME Historic Mechanical Engineering Landmark, following the *Monitor* Historic Trail from New York to North Carolina. The story of the “ship that saved the nation” and of technological innovators like Henry R. Worthington will be shared. Other road trips will take place across the country. When not on the road, the replicated pump is used for programming at The Mariners' Museum and Park.

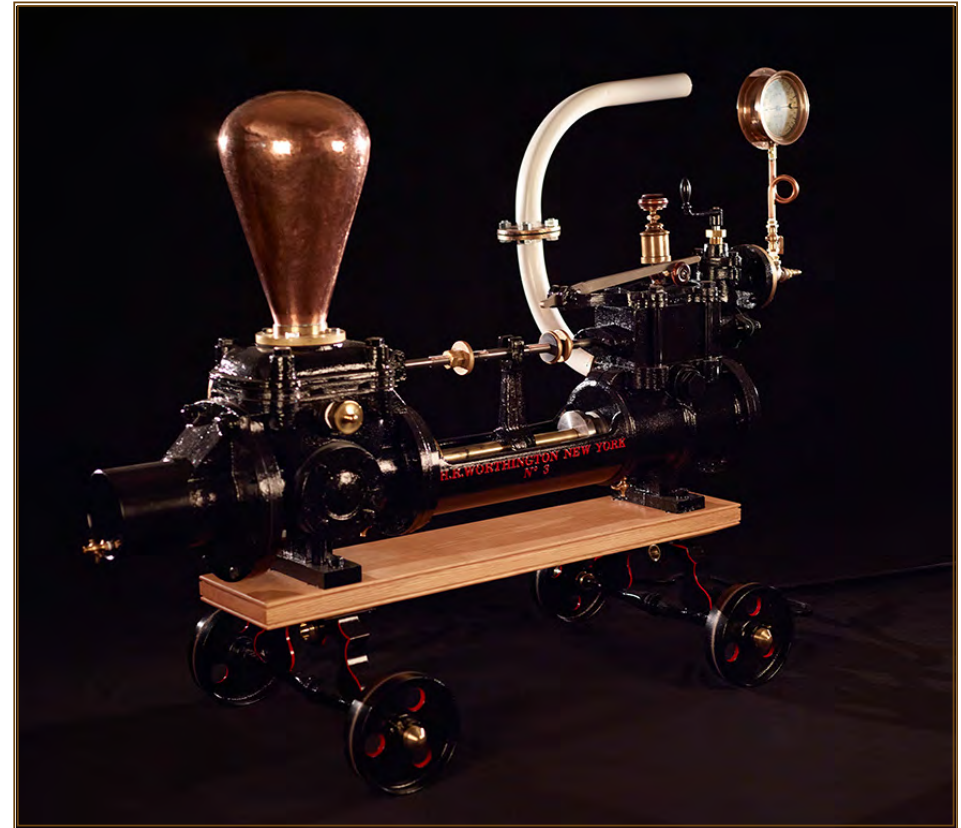

Images courtesy of The Mariners' Museum and Park



Full-size replica of the USS *Monitor* at The Mariners' Museum and Park.

Interested in the
Worthington
pump replica
coming to
your area?

Email [conservation@
MarinersMuseum.org](mailto:conservation@MarinersMuseum.org)



Volunteer Gerry Hanley and Conservation Project Manager and Senior Conservator Will Hoffman with the Worthington pump replica.

The History and Heritage Program of ASME

Since the invention of the wheel, mechanical innovation has critically influenced the development of civilization and industry as well as public welfare, safety, and comfort. Through its History and Heritage Program, the American Society of Mechanical Engineers (ASME) encourages public understanding of mechanical engineering, fosters the preservation of this heritage, and helps engineers become more involved in all aspects of history.

In 1971 ASME formed a History and Heritage Committee composed of mechanical engineers and historians of technology. The Committee is charged with examining, recording, and acknowledging mechanical engineering achievements of particular significance. For more information, please visit www.asme.org.

LANDMARK DESIGNATIONS

There are many aspects of ASME's History and Heritage activities, one of which is the landmarks program. Since the History and Heritage Program began, 261 artifacts have been designated throughout the world as historic mechanical engineering landmarks, heritage collections, or heritage sites. Each represents a progressive step in the evolution of mechanical engineering and its significance to society in general.

The Landmarks Program illuminates our technological heritage and encourages the preservation of historically important works. It provides an annotated roster for engineers, students, educators, historians, and travelers. It also provides reminders of where we have been and where we are going along the divergent paths of discovery.

ASME

ASME helps the global engineering community develop solutions to real-world challenges. ASME, founded in 1880, is a not-for-profit professional organization that enables collaboration, knowledge sharing, and skill development across all engineering disciplines, while promoting the vital role of the engineer in society. ASME codes and standards, publications, conferences, and continuing education and professional development programs provide a foundation for advancing technical knowledge and a safer world.

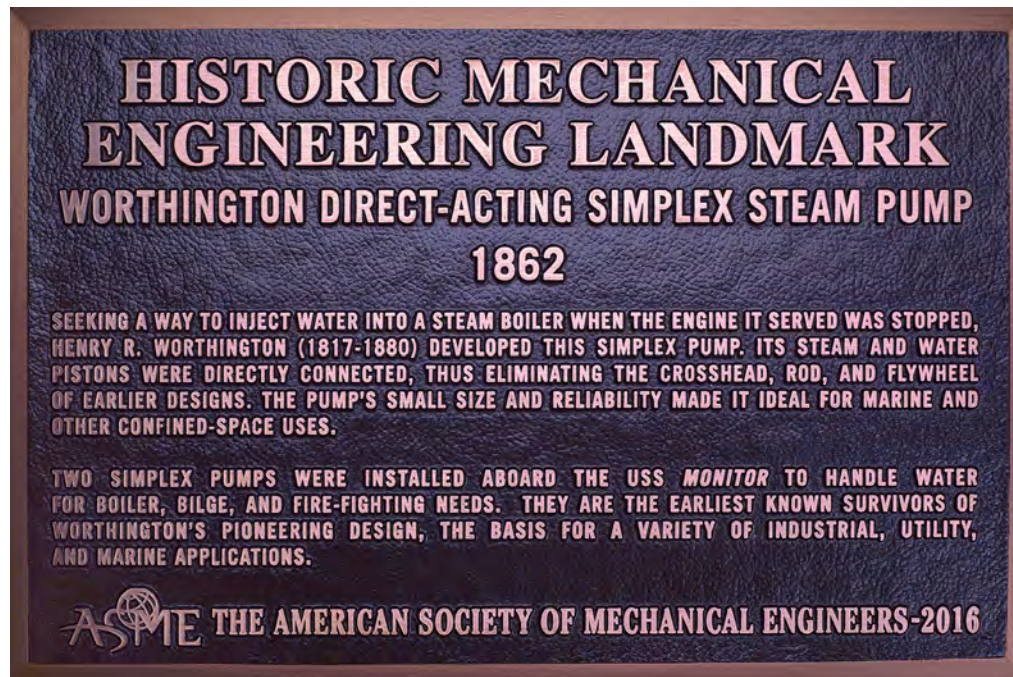

ASME Officers

K. Keith Roe, P.E., President

Thomas G. Loughlin, CAE, Executive Director

ASME Eastern Virginia Section

Dr. John W. Ralls, P.E., Chair

Michael J. Reilley, P.E., Vice Chair

John H. Zinskie, Treasurer

Daniel J. Hebert, Secretary

Kyle A. Wade, Program Chair

Timothy R. Meadows, P.E., Advisor

ASME History & Heritage Committee

Thomas H. Fehring, P.E., Chair

Richard I. Pawliger, P.E., Immediate Past Chair

J. Lawrence Lee, P.E., Past Chair

Terry S. Reynolds

Robert T. Simmons, P.E., Past President

Herman H. Viegas, P.E. (Ret.)

Robert O. Woods, P.E.

Corresponding Members

John K. Brown

Marco Ceccarelli

Lee S. Langston

Francis C. Moon

Paul J. Torpey, Past President

ASME STAFF

Roger Torda, Manager, Communications Projects & Initiatives

Wil Haywood, Communications Coordinator

Special thanks to Curtiss-Wright and ASME Eastern Virginia Section for their event sponsorship.

THE MARINERS' MUSEUM AND PARK

Howard H. Hoege III, Interim President and CEO

USS MONITOR CENTER

John V. Quarstein, Director

William Hoffman, Senior Conservator and Conservation Project Manager

Julie Murphy, Development and Communications Writer

NATIONAL OCEANIC AND ATMOSPHERIC ADMINISTRATION/ NATIONAL MARINE SANCTUARIES

David Alberg, Superintendent, *Monitor* National Marine Sanctuary

Acknowledgments

John Broadwater

Pedro Gonçalves

Gerald Hanley

Anna Holloway

David Krop

Newport News Shipbuilding

Eric Nordgren

Gary Paden

Kenneth Payne

Curtiss Peterson

Marcie Renner

Ricky Sanders

The USS *Monitor* Center thanks the following for their support of the Worthington Pump Replica project:

Curtiss-Wright, Engineered Pump Division

Eight Weight Video

Hampton Rubber Company

Christopher Leahy

Master Machine and Tool, Co., Inc.

Chris Savage

Donald Smith

State University New York College at Buffalo

Pete Veneris

Virginia Institute of Marine Sciences – College of William and Mary

Chris Voll

Gary A. Wainwright

Selected Bibliography

- Björling, Philip R. *Practical Handbook on Direct-Acting Pumping Engine and Steam Pump Construction*. London: E. & F.N. Spon, 1889.
- Giges, Nancy. "Henry R. Worthington, Biography." Accessed January 12, 2016. <http://www.asme.org/engineering-topics/articles/transportation/henry-r-worthington>
- Hoffman, William. "Bringing History to Life: Reproducing a Worthington Steam Pump from the USS *Monitor*." *Objects Specialty Group Postprints*, Vol. 20, 2013. Washington, D.C.: American Institute for Conservation of Historic and Artistic Works, (2015): 169-194.
- Worthington, Henry R. *The Worthington Steam Pumping Engine: History of its Invention and Development*. New York: Worthington, 1886.
- _____ . "Industrial Supplement to Engineering News," *Engineering News and American Railway Journal*. New York: Engineering News Publishing Co. 29 (Jan.-June 1893): 287-292.
- Worthington Pump and Machinery Corporation. *100 years, Worthington, 1840-1940*. Harrison, N.J.: Worthington Pump and Machinery Corporation, 1940.
- "The Manufacture of Pumping Engines and Water Meters." *Scientific American*. September 4, 1880: 149.
- "On a New Direct-Acting Steam Pump." *Institute of Mechanical Engineers, Proceedings*. Birmingham: The Institute (1852): 174-175.

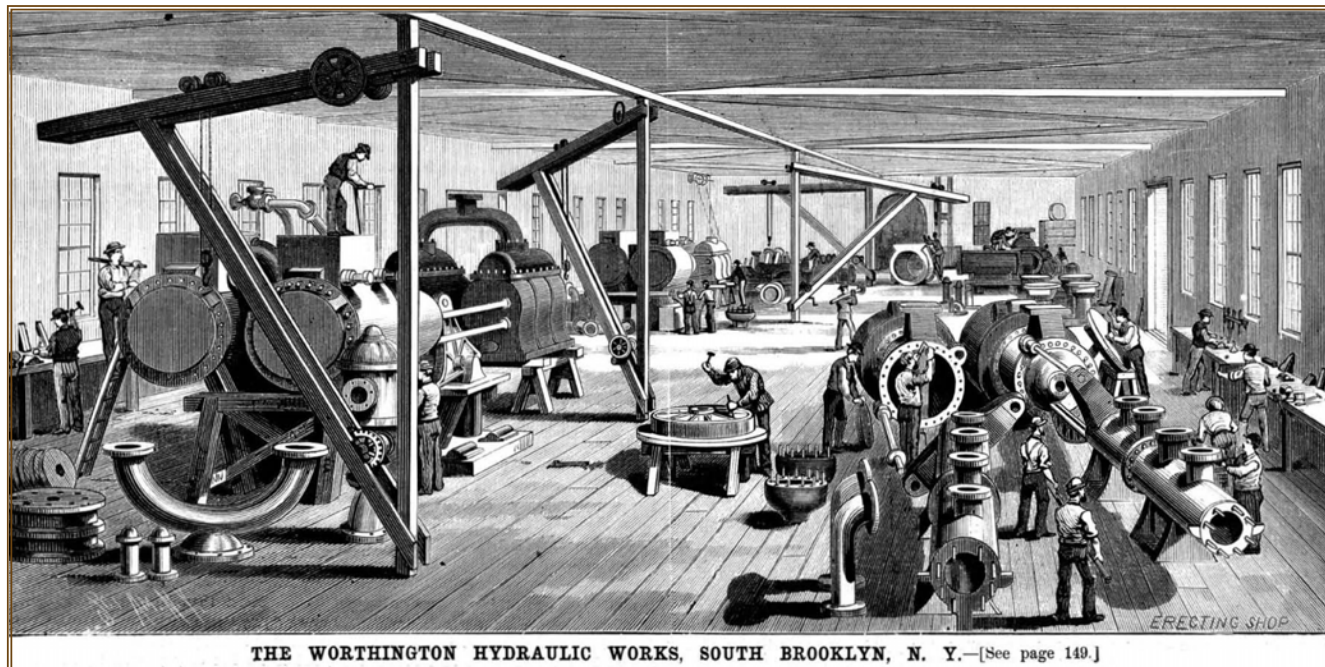
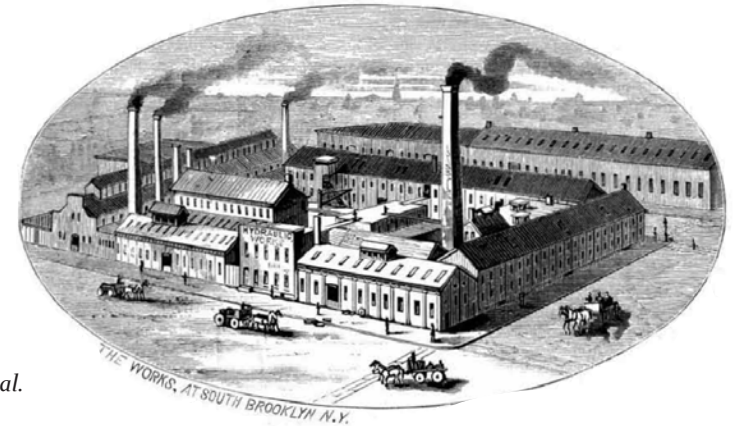

Engravings of Worthington Hydraulic Works, *Scientific American*, September 4, 1880.
Courtesy of The Mariners' Museum and Park

Henry R. Worthington's Legacy

Henry Rossiter Worthington's ingenuity spawned an industry that would become a major manufacturing segment in the United States. Other American engineers have improved on Worthington's various pump designs, primarily in the steam-end valve gear. Of note were Lucius J. Knowles, George F. Blake, and Adam Scott Cameron, all of whom formed companies bearing their names. To this day, Worthington's invention - the "Worthington" direct-acting steam pump - is known by engineers as a type that serves in waterworks, mining, petroleum refining, pipelining, marine applications, the nuclear industry, and a myriad of other processes that involve fluid movement.

From a small factory near the old Navy Yard in Brooklyn, Worthington's company expanded to be a diversified international mechanical engineering presence with products ranging from air compressors to turbines. Most of his competitors were merged into the Worthington Pump Company by the end of the 19th century, and although Worthington's original company no longer exists, its legacy continues to have a global presence today.

Modern branches, although unaffiliated, include companies such as Worthington Compressors, Curtiss-Wright, and Flowserve.

In today's age of computers, high-speed aircraft, and interplanetary voyagers, it is hard to imagine the importance of the invention of a simple pump over 180 years ago.

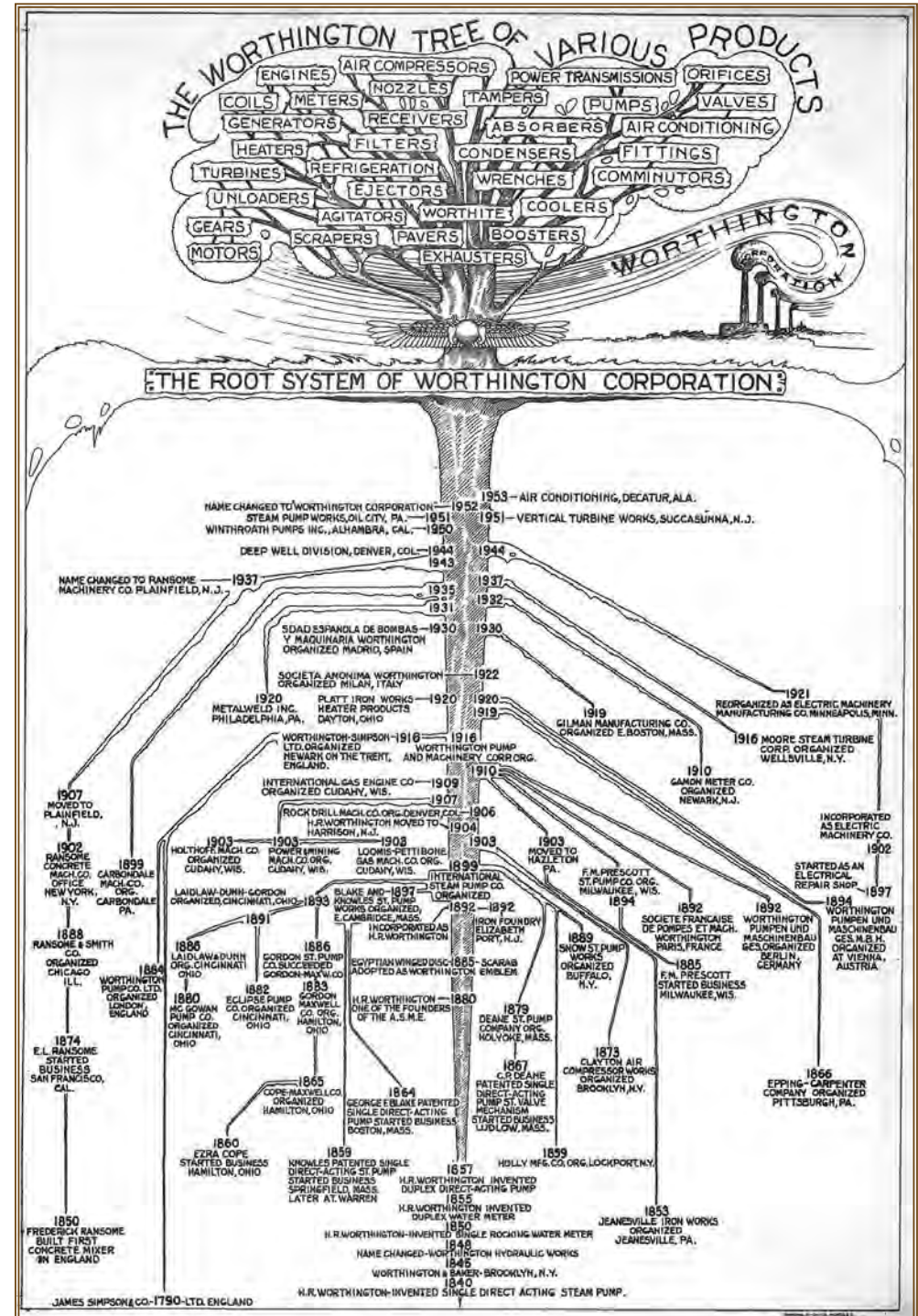

Courtesy of Curtiss-Wright, Engineered Pump Division

“Our chronicle of a century of Worthington achievement ... has but attempted to put into word pictures of some of the significant steps in the growth of an important enterprise, born of the genius of a great man. This has been a hundred years rich in accomplishment ... paralleling, as it has, the period of the world’s greatest advancement in science, in transportation, and in the development of facilities for easing the burdens of mankind.”

– Worthington Pump and Machinery Corporation, *100 years, Worthington, 1840-1940*, 1940.

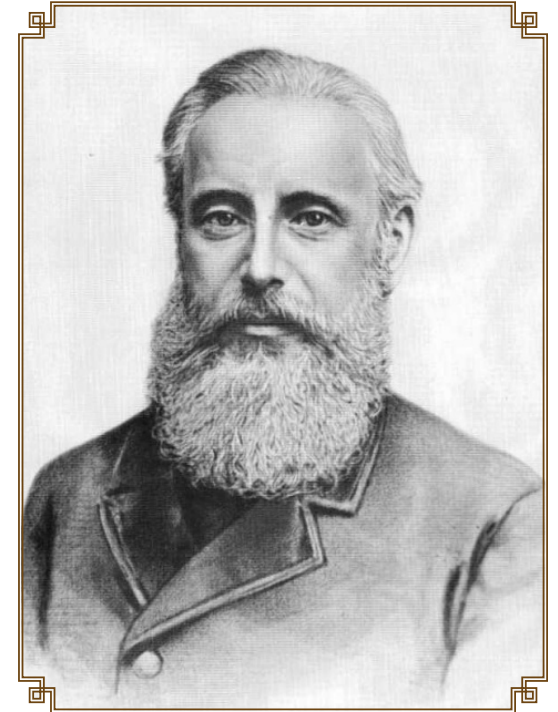

Henry Rossiter Worthington
Courtesy of Wikipedia.com



ASME honors co-founder Henry Worthington

- In 1980 Worthington Pump, Inc. established the Henry R. Worthington Medal, awarded by ASME, recognizing “eminent achievement in the field of pumping machinery, systems and concepts.”
- In 1982 the Worthington Horizontal Cross-Compound Pumping Engine was designated a Historic Mechanical Engineering Landmark by the History and Heritage Committee of ASME, working with the ASME’s Susquehanna Section, York, PA.
- Worthington’s genius continues to be recognized by ASME on August 25, 2016, at The Mariners' Museum and Park.

Cover Images–Background: *Monitor’s* General Plan, drawn by The Continental Iron Works, 1862; and
Inset: detail of the main engine and Worthington pumps from *Monitor’s* General Plan.
Courtesy of *The Mariners’ Museum and Park*

